

NautoPilot® 5000 Series

Adaptive Heading Control System



NautoPilot® 5000 Series

NautoPilot® 5000 is the brand-new autopilot series developed and manufactured by Raytheon Anschütz.

It is the successor of the NautoPilot® 2000 series and based on the proven steering algorithms that are known for outstanding steering performance. It is specially designed for all commercial ships of 100 m length and above.

NP 5000 is not only a successor. It provides a multitude of benefits which today are not known in the market.

The handling of an autopilot has never been easier

All main functions are operated via hard keys and all secondary functions via touch screen. The large graphical display ensures a clearly arranged presentation of information. The menu structure is clear and transparent. You will feel familiar with NP 5000 after a few minutes due to its intuitive operating philosophy.

Your Benefit®

- Precise steering
- Ease of use and intuitive handling
- Simple adjustment of autopilots parameters by use of Heading and Rudder Plotter
- Fuel-Saving thanks to weather adaptivity
- Cross Acceleration Monitor
- New Course Control mode
- Approved for High Speed Crafts
- Approved as part of a Track Control System in combination with Raytheon Anschütz ECDIS

Six different day and night modes ensure optimal readability under different ambient conditions



NautoPilot® 5000 main screen with touch operation

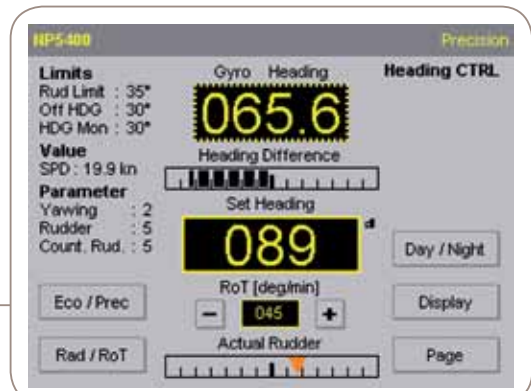

Acceleration Monitor

An unique feature for the new NP 5000 is the Acceleration Monitor. It monitors the cross acceleration of a ship and provides a warning if a user defined threshold is exceeded. Thus NP 5000 increases safety for life, ship and cargo. Damages or accidents are avoided due to this unique feature of NP 5000.

Course Control

Often Heading Control and Course Control are used synonymously. But in fact it is significant difference for navigation. In Heading Control it is necessary to compensate for drift manually. To overcome this disadvantage Raytheon Anschütz introduces the new Course Control mode. No manual drift corrections are required as the NP 5000 steers the vessel on a course over ground line. This leads to a more precise steering especially if wind or drift affects the vessel.

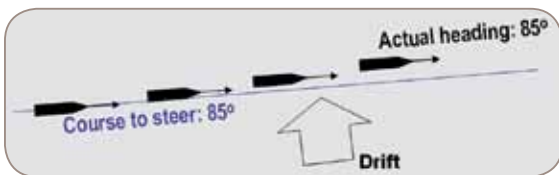

In Heading Control the course over ground line is affected by drift and wind

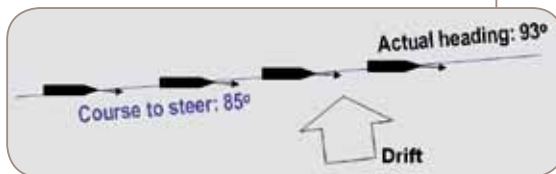

In Course Control the vessel stays on its course over ground line independently of drift and wind

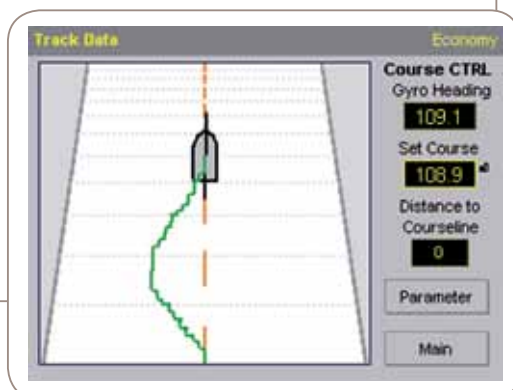

NautoPilot® 5000 illustrates graphically any deviations from the course over ground line

NautoPilot® 5000 as part of a Track Control System

The new NP 5000 is approved as a Track Control System in combination with Raytheon Anschütz ECDIS. It fulfils category B and the highest category C.



Route planning is done on ECDIS and NP 5000 ensures accurate track steering

Do you care about fuel consumption?

If yes, NP 5000 should be your autopilot of choice. Each single rudder activity increases fuel consumption and costs. For this purpose NP 5000 can adapt automatically to the current weather and sea conditions. In Economy Mode rudder activity is reduced to a minimum for best fuel efficiency.

In addition NP 5000 is equipped with an integrated Heading and Rudder Plotter. The steering performance of the vessel is graphically displayed by showing rudder activity and heading changes. It has never been easier to adjust an autopilot for best steering performance and again efficient fuel consumption.

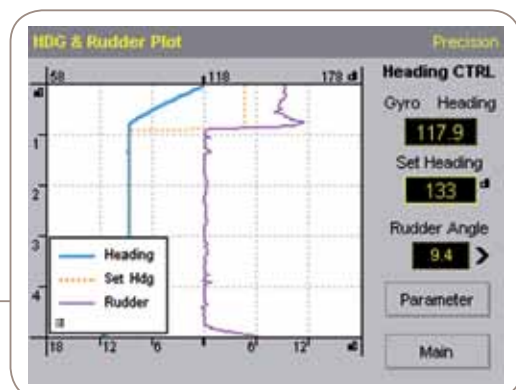

Rudder activity and heading changes are displayed. Autopilot settings can directly be changed

Technical Data

Supply Voltage

24 V DC (18-36 V DC)

Power Consumption

Approx. 25 W

Signal Inputs

Gyro compass, satellite compass

- Course Bus or NMEA telegrams HEHDT, HETHS, GPHDT, GPTHS

Magnetic Compass / Fluxgate

- Course Bus or NMEA telegrams HCHDT, IHDM, HCHDG, HCTHS
- With magnetic compass sonde 108-010

Speed log

- Course Bus or NMEA telegrams VTG, VHW, VBW (with talker identifier VD, VM, VW, GP)
- 200 pulses/nm

Position Receiver

- NMEA telegrams GPGLL, GPGGA

ECDIS

- according to IEC 62065 (track control)
- NMEA telegram APB (waypoint steering for NP 5100 and NP 5300)

Signal Outputs

Outputs to steering gear

- 2 switching outputs (24V DC – 110V DC, max. 48 W)
- 2 analog outputs (+/- 10 V DC, max. 5 mA)

Status/alarm outputs

- Off-heading
- Heading monitor
- Steering failure
- System failure
- Bi-directional central alarm reset
- Autopilot on

In accordance with

- ISO 11674
 - IEC 62065 (in combination with Raytheon Anschütz ECDIS)
 - NMEA according to EN/IEC 61162-1 and EN/IEC 61162-2
 - EN/IEC 60945
 - ISO 16329
 - A.342(IX), A.694(17), MSC.64(67) Annex 3, A.822(19)
- For details refer to EC-type examination certificate.

Type of enclosure acc. to IEC/EN 60529

- Autopilot operator unit: IP23 / IP56 (front side)
- Autopilot interface: IP 12

General Data

Temperature range

- Operation: -25°C to + 55°C (autopilot operator unit)
-15°C to + 55°C (autopilot interface)
- Storage: -40°C to + 70°C

NavtoPilot® is a registered trademark of Raytheon Anschütz GmbH

NavtoPilot 5000 variants

	Heading Control	Course Control	Weather Adaptivity	Track Control Category B	Track Control Category C	Cross Acceleration Monitor	High Precision Controller
NP 5100	✓			✓			
NP 5300	✓	✓	✓	✓			
NP 5400	✓	✓	✓		✓	✓	
NP 5500	✓	✓	✓		✓	✓	✓

NavtoPilot 5500 is intended for use in areas where highest precision is required such as archipelagos

Autopilot operator unit 1.5 kg

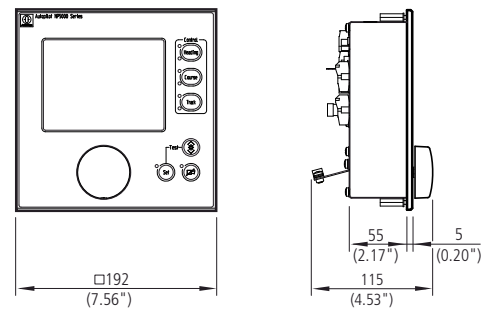

Autopilot interface 3 kg

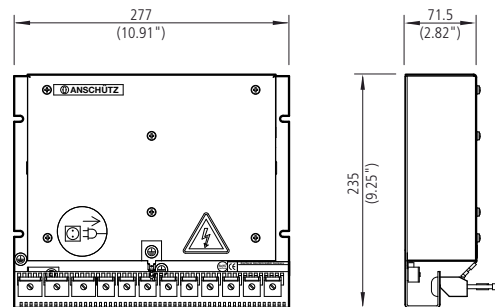

Feedback unit 4 kg

